

ETON 35L SOLID DOOR MINIBAR

SILENT OPERATION

Will not disturb sleeping guests

PELTIER COOLING TECHNOLOGY WITH CONDENSER

Efficient cooling

LEFT OR RIGHT OPENING

Flexible use



R600A REFRIGERANT

Environmentally friendly coolant

INTERIOR LED LIGHT

ADJUSTABLE SHELVING SYSTEM

Can be configured to different sized items

- F energy rating
- Can accommodate a 1L bottle of water/wine
- Lockable door
- Supplied with 2 keys
- Adjustable cooling dial

Specification

Black
10.1kg
35L
58W
R600a refrigerant (Non-ammonia coolant)
50mm ventilation gap required
Insulation: Cyclopentane

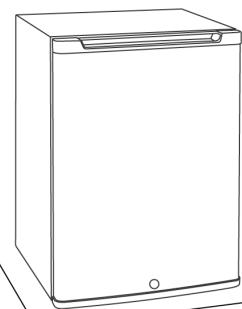
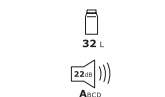
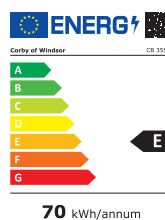

455mm 17.91in
385mm 15.16in
475mm 18.70in

MINIBAR À PORTE SOLIDE ETON DE 35 L

FONCTIONNEMENT SILENCIEUX

Ne dérangera pas les clients pendant leur sommeil

TECHNOLOGIE DE REFRIGERISSEMENT PELTIER AVEC CONDENSEUR

Refrigerissement efficace

OUVERTURE GAUCHE OU DROITE

Utilisation flexible



RÉFRIGÉRANT R600A
Réfrigérant écologique

ÉCLAIRAGE LED INTÉRIEUR

SYSTÈME D'ÉTAGÈRES AJUSTABLE
Peut-être configuré pour différents objets

- Classe énergétique F
- Peut contenir une bouteille d'eau/vin de 1 L
- Porte verrouillable
- Fourni avec 2 clés
- Sélecteur de refroidissement ajustable

Spécifications

Noir
10,1 kg
35 L
58 W
Réfrigérant R600a (Réfrigérant non ammoniacal)
Espace de ventilation de 50 mm requis
Isolation: Cyclopentane

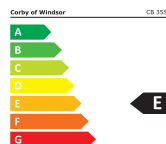

70 kWh/annum

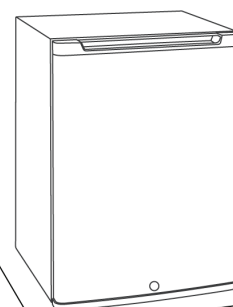

455mm
17.91in

385mm
15.16in

475mm
18.70in

MINIBAR DE PUERTA SÓLIDA ETON DE 35 L

FUNCIONAMIENTO SILENCIOSO

No perturbará a los huéspedes mientras duermen

TECNOLOGÍA DE ENFRIAMIENTO PELTIER CON CONDENSADOR

Enfriamiento eficiente

APERTURA IZQUIERDA O DERECHA

Uso flexible



REFRIGERANTE R600A
Refrigerante ecológico

LUZ LED INTERIOR

SISTEMA DE ESTANTERÍAS AJUSTABLE
Puede configurarse para diferentes tamaños de objetos

- Clasificación energética F
- Puede albergar una botella de agua/vino de 1 L
- Puerta con cerradura
- Suministrado con 2 llaves
- Selector de enfriamiento ajustable

Especificaciones

Negro
10,1 kg
35 L
58 W
Refrigerante R600a (Refrigerante no amoniacal)
Se requiere espacio de ventilación de 50 mm
Aislamiento: Ciclopentano

DISEÑADO PARA EL SECTOR HOTELERO	3 YEAR GARANTÍA ELÉCTRICA	DISEÑO BRITÁNICO	ECOLÓGICO	ENFRIAMIENTO AJUSTABLE	LUZ LED INTERIOR
FUNCIONAMIENTO SILENCIOSO	APERTURAS DE PUERTA IZQUIERDA Y DERECHA	PUERTA CON CERRADURA			

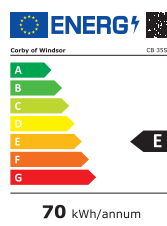

32 L
 22dB A_{eq}

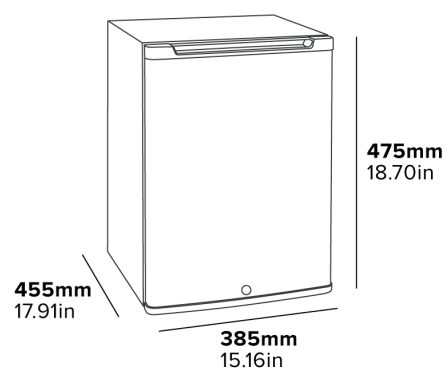

ETON 35 L MINIBAR MIT FESTER TÜR

LEISER BETRIEB

Stört die schlafenden Gäste nicht

PELTIER-KÜHLTECHNOLOGIE MIT KONDENSATOR

Effiziente Kühlung

LINKS ODER RECHTS ZU ÖFFNEN

Flexibler Einsatz



R600A KÄLTEMITTEL

Umweltfreundliches Kühlmittel

LED-INNENBELEUCHTUNG

VERSTELLBARES REGALSYSTEM

Kann für verschiedene Größen konfiguriert werden

- Energiestufe F
- Kann eine 1 L Flasche Wasser/Wein aufnehmen
- Abschließbare Tür
- Wird mit 2 Schlüsseln geliefert
- Einstellbares Kühlrad

Beschreibung

Schwarz

10,1 kg

35 L

58 W

Kältemittel R600a (ammoniakfreies Kühlmittel)

50mm Lüftungsspalt erforderlich

Isolierung: Cyclopentan

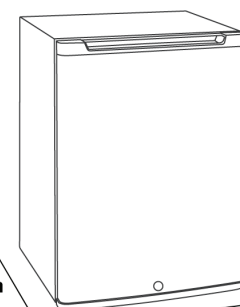
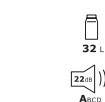
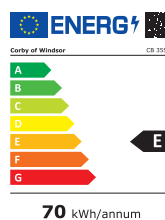

455mm
17.91in

385mm
15.16in

475mm
18.70in

MINIBAR ETON DA 35 L CON PORTA CIECA

FUNZIONAMENTO SILENZIOSO

Non disturberà gli ospiti durante il loro riposo

TECNOLOGIA DI RAFFREDDAMENTO PELTIER CON CONDENSATORE

Raffreddamento efficiente

APERTURA SINISTRA O DESTRA

Utilizzo flessibile



REFRIGERANTE R600A

Liquido refrigerante ecologico

LUCE INTERNA A LED

SISTEMA DI SCAFFALI REGOLABILI

Può essere configurato per articoli di dimensioni

- Classe energetica F
- Può contenere una bottiglia di acqua/vino da 1 litro
- Porta con serratura
- Fornito con 2 chiavi
- Quadrante di raffreddamento regolabile

Caratteristiche

Nero
10,1 kg
35 L
58 W
Refrigerante R600a (Refrigerante senza ammoniaca)
È richiesto uno spazio di ventilazione di 50 mm
Isolamento: Ciclopentano

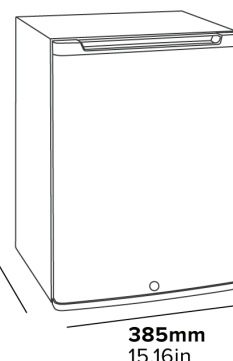
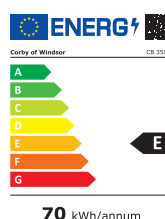

MINIBAR Z SOLIDNYMI DRZWIAMI ETON 35 L

CICHA OBSŁUGA

Nie przeszkadza śpiącym gościom

TECHNOLOGIA CHŁODNICZA

PELTIER ZE SKRAPLACZEM
Wydajne chłodzenie

OTWIERANIE W

LEWO LUB W PRAWO
Elastyczne zastosowanie



CZYNNIK CHŁODZĄCY R600A
Przyjazne środowisku chłodziwo



WEWNĘTRZNA LAMPKA LED

SYSTEM PÓLEK REGULOWANYCH

Można skonfigurować pod przedmioty różnych rozmiarów

- Klasa energetyczna F
- Pomieści butelkę wody/wina 1 L
- Zamykane drzwi
- W zestawie 2 klucze
- Regulowane pokrętko chłodzenia

Specyfikacja

Czarny
10,1 kg
35 L
58 W
Czynnik chłodzący R600a (Chłodziwo bezamoniakowe)
Wymagana luka wentylacyjna 50 mm
Izolacja: Cyklopentan



Z MYŚLĄ O HOTELACH



3 YEAR GWARANCJA ELEKTRYCZNA



BRYTYJSKI DESIGN



EKOLOGICZNY



REGULOWANE CHŁODZENIE



WEWNĘTRZNA LAMPKA LED



CICHA OBSŁUGA



OTWIERANIE DRZWI L + P



ZAMYKANE DRZWI

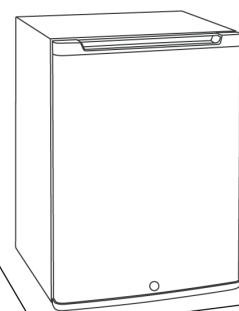
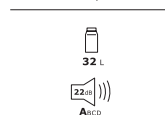
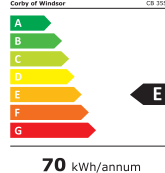

455mm
17.91in

385mm
15.16in

475mm
18.70in

MINIBAR ETON CU UȘĂ SOLIDĂ 35 L

FUNȚIONARE SILENȚIOASĂ

Nu deranjează oaspeții care dorm

TEHNOLOGIE DE RĂCIRE PELTIER CU CONDENSATOR

Răcire eficientă

DESCHIDERE LA STÂNGA SAU LA DREAPTA

Utilizare flexibilă



AGENT FRIGORIFIC R600A
Agent de răcire ecologic

LUMINĂ INTERIOARĂ CU LED

SISTEM CU RAFTURI REGLABILE
Poate fi configurat pentru articole de dimensiuni diferite

- Clasificare energetică F
- Poate găzdui o sticlă de apă/vin de 1 L
- Ușă cu încuietoare
- Vine la pachet cu 2 chei
- Cadran reglabil pentru răcire

Specificații

Negru
10.1 kg
35 L
58 W
Agent frigorific R600a (agent de răcire fără amoniac)
Este necesar un spațiu de ventilație de 50 mm
Izolație: Ciclopentan

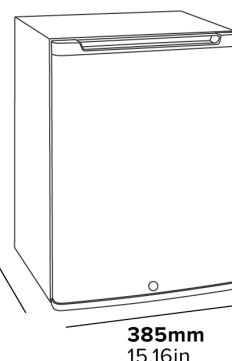
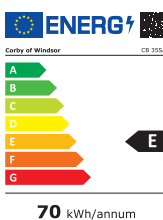

ETON 35 L MINIBAR S PEVNÝMI DVEŘMI

TICHÝ PROVOZ
Neruší spící hosty

**PELTIEROVA TECHNOLOGIE
CHLAZENÍ S KONDENZÁTOREM**
Účinné chlazení

**LEVÉ NEBO
PRAVÉ
OTEVÍRÁNÍ**
Flexibilní použití



CHLADIVO R600A
Chladicí kapalina šetrná k životnímu prostředí

**VNITŘNÍ LED
SVĚTLA**

NASTAVITELNÝ REGÁLOVÝ SYSTÉM
Lze konfigurovat na různé velikosti položek

- Energetická třída F
- Vejde se do ní 1l láhev vody/vína
- Uzamykatelné dveře
- Dodává se se 2 klíči
- Nastavitelný volič chlazení

Specifikace

Černá
10,1 kg
35 L
58 W
Chladivo R600a (neamoniakální chladivo)
Vyžaduje se 50 mm větrací mezera
Izolace: Cyklopentan



UVEDENÝ
HOTEL



3
YEAR
ELEKTRICKÁ
ZÁRUKA



BRITSKÝ
DESIGN



EKOLOGICKY
SETRNÉ



NASTAVITELNÉ
CHLAZENÍ



VNITŘNÍ
LED SVĚTLA



TICHÝ
PROVOZ



L + R DVEŘNÍ
OTVORY



ZAMYKATELNÉ
DVEŘE

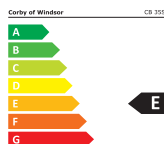

70 kWh/annum



32 L



22dB(A)

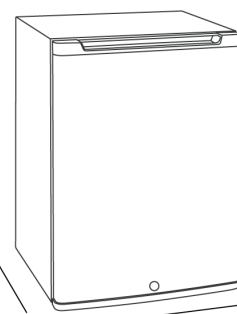

455mm
17.91in

385mm
15.16in

475mm
18.70in